

3.3V 2A Low-Dropout Regulator with Disable

Features

Dropout-voltage 0.5V @ $I_o = 2A$
Output current in excess of 2A
Output voltage accuracy $\pm 2.5\%$
Quiescent current typically 5mA
Internal short-circuit current limit
Internal over-temperature protection
TO-220 4pin Full-Mold package
ON/OFF control

General Description

The SS8046 positive 3.3V voltage regulator features the ability to source 2A of output current. The dropout voltage is 0.5V at 2A output current. The typical quiescent current is 5mA. Furthermore, the quiescent current is smaller when the regulator is in the dropout mode ($V_{IN} < 3.3V$).

Familiar regulator features such as over-temperature and over-current protection circuits are provided to prevent the device from being damaged by abnormal operating conditions. A V_{dis} pin is provided to disable the output when needed.

Ordering Information

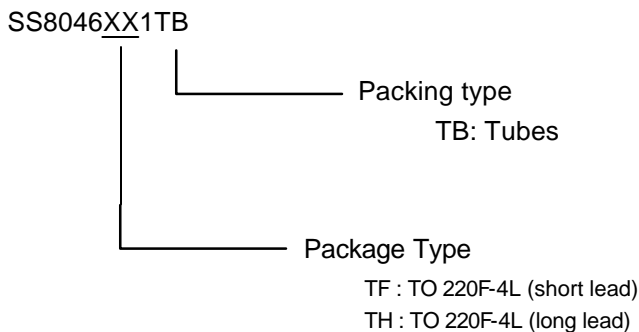

Example: SS8046TF1TB
 → SS8046 in TO 220F-4L (short lead) shipped in tubes

Typical Application

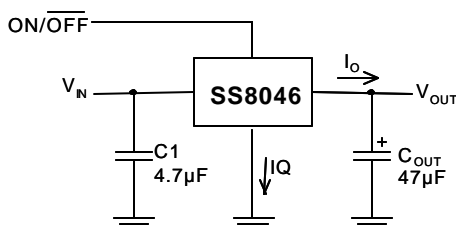

Pin Configuration

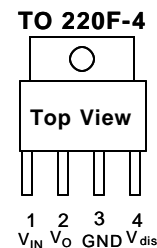

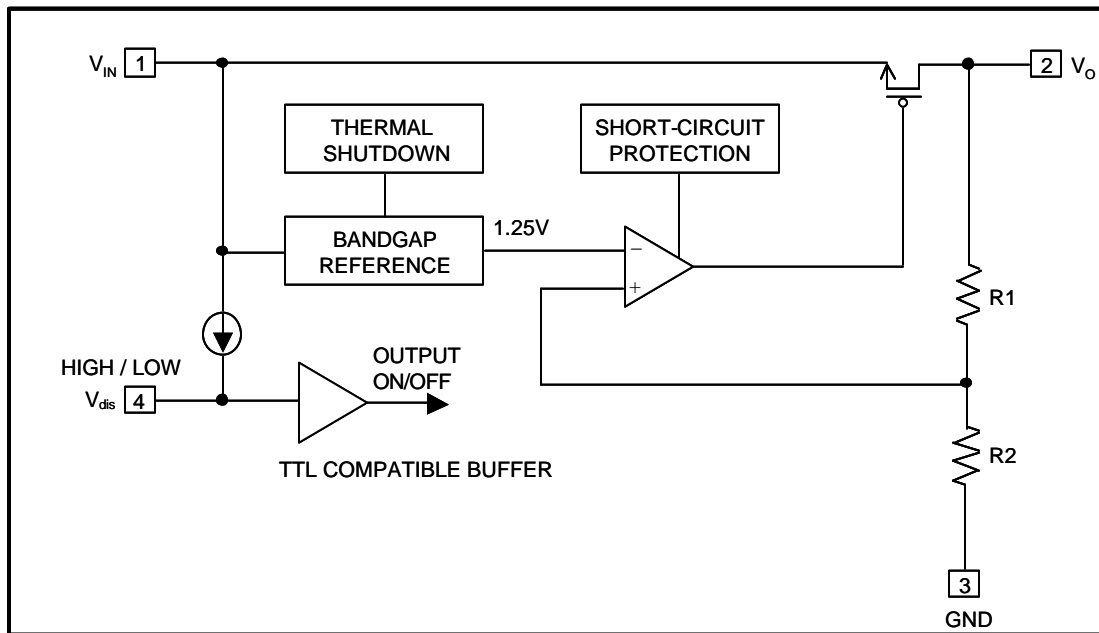
Block Diagram

Absolute Maximum Ratings

Input Voltage.....	8V	(Note 1)
V_{dis} Voltage.....	8V	
Power Dissipation Internally Limited		(Note 2)
Maximum Junction Temperature.....	150°C	
Storage Temperature Range.....	$-65^{\circ}\text{C} \leq T_J \leq +150^{\circ}\text{C}$	
Lead Temperature, Time for Wave Soldering		
TO 220 Package.....	260°C, 10s	
Continuous Power Dissipation ($T_A = +25^{\circ}\text{C}$)		
TO 220 No heatsink.....	1.5W	
TO 220 with infinite heatsink.....	15W	

Operating Conditions

Input Voltage.....	3.6V~7V	(Note 1)
Temperature Range.....	$-20^{\circ}\text{C} \leq T_A \leq 85^{\circ}\text{C}$	

Electrical Characteristics

$V_{IN} = 5V$, $I_O = 0.5A$, $C_{IN} = 4.7\mu F$, $C_{OUT} = 47\mu F$, $T_A = T_J = 25^\circ C$ unless otherwise specified [Note 3]

PARAMETER	SYMBOL	CONDITIONS	MIN	TYP	MAX	UNITS
Output Voltage		$I_O = 0.5A$	3.22	3.3	3.38	V
Line Regulation		$4V \leq V_{IN} \leq 7V$, $I_O = 10mA$		0.5	2	%
Load Regulation		$50mA \leq I_O \leq 2A$		0.5	2	%
Quiescent Current		$V_{IN} = 5V$		5	10	mA
Ripple Rejection		$f_i = 120Hz$, 1VP-P, $I_O = 100mA$		45		dB
Dropout Voltage		$I_O = 2A$			0.5	V
Short Circuit Current				3.8		A
Over Temperature				150		$^\circ C$
Disable Voltage High	V_{disH}	Output Active	2.0			V
Disable Voltage Low	V_{disL}	Output Disabled			0.8	V
Disable Bias Current High	I_{disH}	$V_{dis} = 2.7V$			20	μA
Disable Bias Current Low	I_{disL}	$V_{dis} = 0.4V$			20	μA

Note 1: Absolute Maximum Ratings are limits beyond which damage to the device may occur. Operating Conditions are conditions under which the device functions but the specifications might not be guaranteed. For guaranteed specifications and test conditions see the Electrical Characteristics.

Note 2: The maximum power dissipation is a function of the maximum junction temperature, T_{Jmax} , total thermal resistance, θ_{JA} , and ambient temperature T_A . The maximum allowable power dissipation at any ambient temperature is $T_{Jmax} - T_A / \theta_{JA}$. If this dissipation is exceeded, the die temperature will rise above $150^\circ C$ and the device will go into thermal shutdown. For the TO 220 package, θ_{JA} is $60^\circ C/W$ (No heat sink).

Note3: Low duty pulse techniques are used during test to maintain junction temperature as close to ambient as possible.

Note4: The output capacitor should be a tantalum or aluminum type.

Definitions

Dropout Voltage

The input/output voltage differential at which the regulator output no longer maintains regulation against further reductions in input voltage. Measured when the output drops 2% below its nominal value, dropout voltage is affected by junction temperature, load current and minimum input supply requirements.

Line Regulation

The change in output voltage for a change in input voltage. The measurement is made under conditions of low dissipation or by using pulse techniques such that average chip temperature is not significantly affected.

Load Regulation

The change in output voltage for a change in load current at constant chip temperature. The measurement is made under conditions of low dissipation or by using pulse techniques such that average chip temperature is not significantly affected.

Maximum Power Dissipation

The maximum total device dissipation for which the regulator will operate within specifications.

Quiescent Bias Current

Current which is used to operate the regulator chip and is not delivered to the load.

Typical Performance Characteristics (continued)

Dropout Voltage vs. Temperature

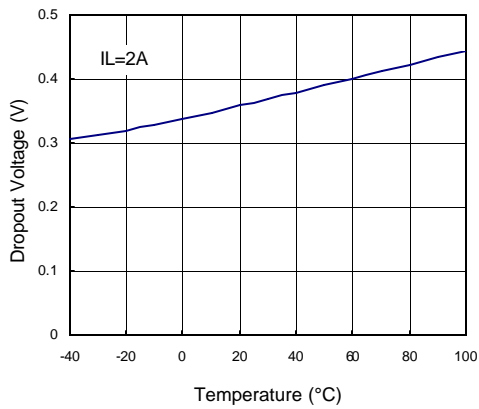

Load Regulation

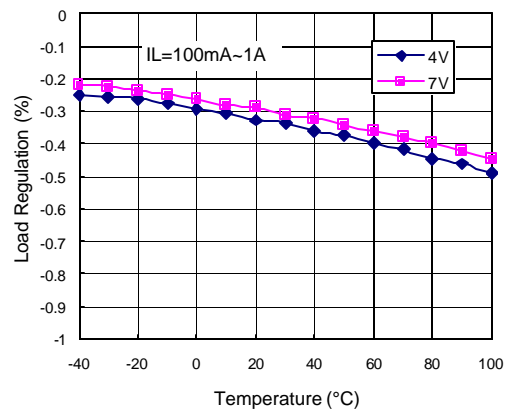

Output Voltage vs. Temperature

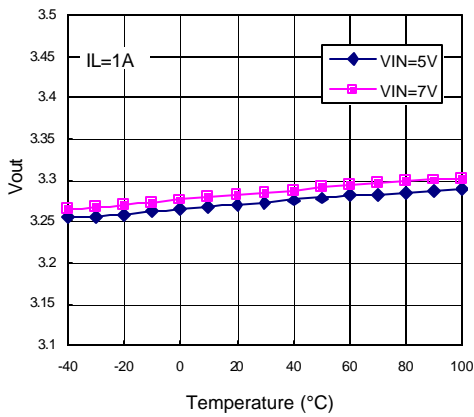

Quiescent Current vs. Temperature

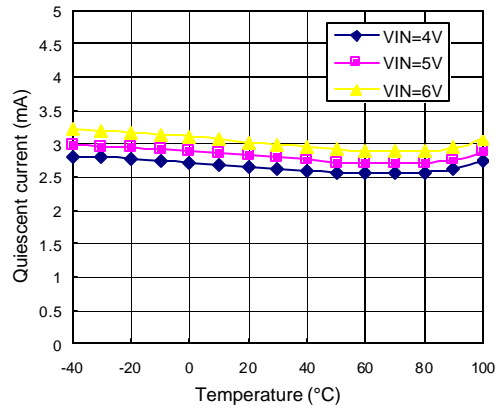

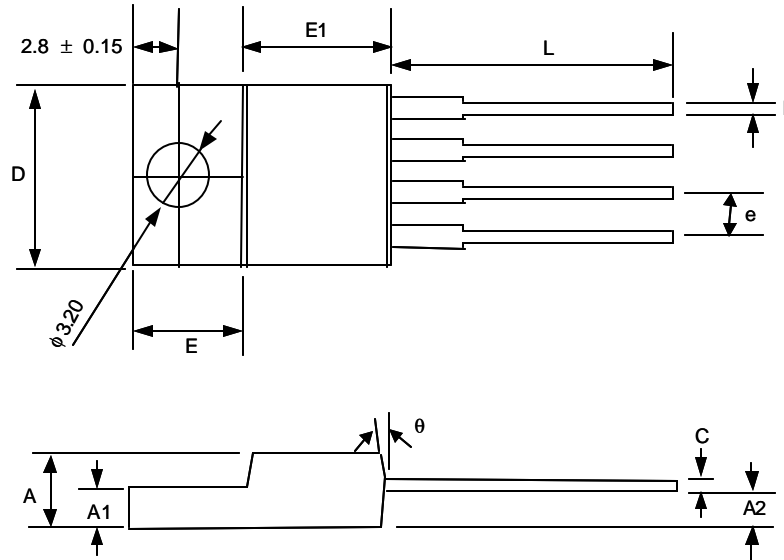
TO 220F-4 Package (long lead)
Note:

1. Lead frame material: TAMAC-4
2. Solder plating thickness: $10 \pm 5 \mu\text{m}$
3. Package body size include mold flash and gate burr
4. Tolerance $\pm 0.1\text{mm}$ unless otherwise specified
5. End flash Max. 0.05mm
6. Mismatch Max. 0.05mm
7. Misalignment Max. 0.05mm
8. Epoxy molding compound: SUMITOMO 6300H or equivalent
9. Matte finish Ra: $0.2 \mu\text{m} \sim 0.8 \mu\text{m}$ top and bottom surface

SYMBOL	DIMENSION IN MM			DIMENSION IN INCH		
	MIN.	NOM.	MAX.	MIN.	NOM.	MAX.
A	4.42	4.57	4.72	0.174	0.180	0.186
A1	2.69	2.79	2.89	0.106	0.110	0.114
A2	1.68	1.78	1.88	0.066	0.070	0.074
D	10.00	10.10	10.20	0.400	0.404	0.408
E	6.25	6.35	6.45	0.246	0.250	0.254
E1	8.54	8.64	8.74	0.336	0.340	0.344
L	13.70	13.90	14.10	0.539	0.547	0.555
C	-----	0.48	-----	-----	0.019	-----
e	-----	2.54(TYP)	-----	-----	0.1(TYP)	-----
b	-----	0.635(TYP)	-----	-----	0.025(TYP)	-----
?	4°	7°	11°	4°	7°	11°

Information furnished by Silicon Standard Corporation is believed to be accurate and reliable. However, Silicon Standard Corporation makes no guarantee or warranty, express or implied, as to the reliability, accuracy, timeliness or completeness of such information and assumes no responsibility for its use, or for infringement of any patent or other intellectual property rights of third parties that may result from its use. Silicon Standard reserves the right to make changes as it deems necessary to any products described herein for any reason, including without limitation enhancement in reliability, functionality or design. No license is granted, whether expressly or by implication, in relation to the use of any products described herein or to the use of any information provided herein, under any patent or other intellectual property rights of Silicon Standard Corporation or any third parties.